

RADIO & MODEL ENGINEERING

Edited by ~ M.B.Sleeper

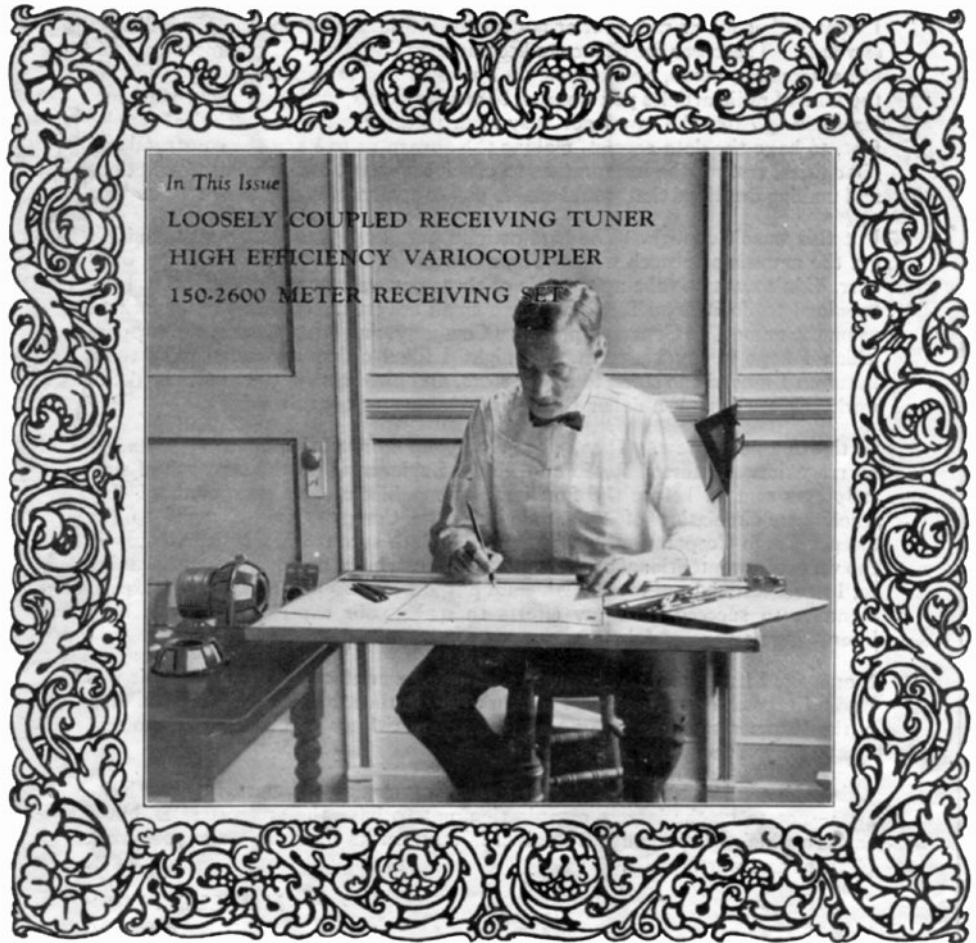

10 Cents a Copy

DECEMBER 1922

\$1.00 Per Year

A Magazine For The Experimenter Who Builds His Own Equipment

Between You and Me

I'm going to tell you a little story. I hope you'll be interested because it's a new story—one that's never been published before.

In 1915, when I saw the first copy of *Everyday Engineering Magazine*, I decided I wanted to work for that company. When they told me they couldn't hire me because they didn't have money enough, I said that was no excuse because I was going to work for 'em anyway. They hired me at six dollars a week.

I wanted that job as radio editor not for the six dollars but for the possibilities I saw in it. There was the chance to become acquainted with Experimenters, their ideas, troubles, needs, and interests. I worked and studied to give you fellows the kind of radio articles you wanted, to answer your questions without your asking them. After the war I got busy again, straightening out technical tangles first, to have the data correct, making the apparatus to learn the constructional difficulties, testing the instruments to check my work, and writing descriptions and making drawings that would enable you to successfully duplicate my results.

But this wasn't enough. The best articles were useless to a man who couldn't get the materials to work with. The managers of *Everyday Engineering*, however, didn't want to take up the sale of those parts and supplies. Finally, I determined to do it myself. I put some small advertisements in the magazines, using the name *The General Apparatus Company*, and bought a stock of supplies which I kept in my bedroom. At night I filled orders and answered letters. Later on I moved the stock to a tiny store, and hired a man to handle the detail work. When I made a dollar I put it into more stock or advertising.

So the Company grew. Then, when *Everyday* stopped, I had the supplies but no magazine. I started *Radio and Model Engineering* on the strength of subscriptions sent in before the first issue was published. It prospered, quickly reaching a circulation of 15,000 copies. The Company was changed to the *Sleeper Radio Corporation*. It prospered. Both succeeded, I believe, because, tho we made unintentional mistakes just as we catch the measles without meaning to, I never lost sight of my fundamental purpose—to keep faith with you Experimenters, to succeed thru my efforts to make your experimental work both interesting and successful.

Moreover, I have tried to be square with other manufacturers. Whether it was *Radio Corporation* saying that I couldn't play in the same yard with the children of the *Regenerative Family* or a small concern with an idea on a design to sell. I have played the game.

This is the real story of the *Sleeper Radio Corporation*, its start, its growth, its aims—not to be the largest organization, not to have the greatest sales, but a concern which I hope you will think of in terms of its efforts to make your work pleasant and worth while.

M. B. SLEEPER,
President.

Loosely Coupled Receiving Tuner

This receiving set, covering a range of 150 to 600 meters, can be used with a crystal detector and amplifier or audion detector.

Receiving Without Feedback

THERE is still a persistent demand for receiving tuners designed to be used with crystal detectors. Many experimenters who have started out with the crystal prefer to use it with audion amplifiers rather than the vacuum tube detectors. It is a fact that a crystal detector in a non-regenerating receiving set frequently gives as good results

broadcasting station of two operating on 360 and 400 meters.

It is very possible, that when the broadcasting situation in this country is finally straightened out experimenters will be forbidden to use oscillating circuits during broadcasting periods as is the case already in England. Then, particularly, this type of set will experience great popularity.



Fig. 1 A splendid receiving tuner for short wave reception. Units and ten switches control the primary inductances while a variable condenser tunes the secondary circuit

or better than an audion. To those who still cling to the crystal, this set has a considerable appeal for it gives high efficiency on short wavelengths and is so sharply tuned, owing to the inductive coupling between the antenna and detector circuits, that it cuts out interference quite readily, a particular boon to those who have experienced trouble in picking out one

Looking over the illustrations of the outfit you will see that it is made up of a variocoupler designed for 150 to 600 meters with an antenna of approximately 0.0003 mfd., and a variable condenser for secondary tuning. The two switches give large and small step adjustments on the antenna or primary inductance while the secondary or detector circuit is tuned

by varying the condenser which is used in conjunction with the fixed inductance of the coupling ball. When the turns on the coupling ball are parallel with the turns on the antenna coil coupling is at maximum. Rotating the ball reduces the coupling and sharpens the tuning.

The panel measures $7\frac{1}{2}$ by 10 ins., a convenient size, on which the controls are arranged to line up with the 2-step amplifier described separately for those who wish to amplify the signals as they are received on the crystal detector.

wire slightly at the point where the tap is to be taken off and fit under the bare portion of a short narrow strip of copper foil. When the coil is completed we then put just a dot of solder at each tap to insure a perfect joint between the wire and copper foil strip. The other end of the copper foil is then rolled over a nail, making a little tube into which the connection wire for the tap can be soldered. No. 24 bare copper wire, B. & S. gauge (22 S. W. G.) covered with Empire tubing is about right for this purpose.

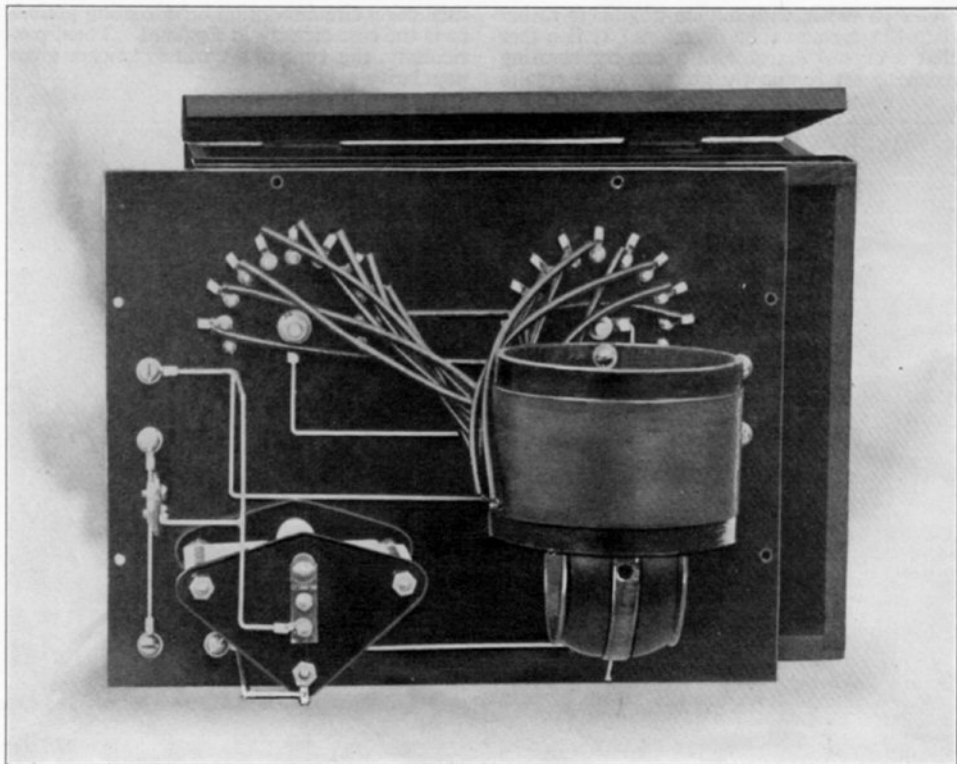

Fig. 2. This rear view shows the variocoupler and the secondary condenser

Winding the Coils

An L. P. F. tube $3\frac{1}{2}$ ins. in diameter and $2\frac{1}{2}$ ins. long with a wall of $\frac{1}{8}$ in. carries the primary inductance. Fig. 6 shows the details of the winding. The start of the winding is $\frac{3}{8}$ in. from the end, using No. 24 S. S. C. wire B & S gauge, and taps are taken off at 0, 1, 2, 3, 4, 5, 6, 7, and 8 turns for the small steps and at 8, 16, 24, 32, 40, 48, 56, 64, and 72 turns for the large steps. Note that the last small steps tap and first large steps tap are common. Any of the conventional methods for tapping can be employed. We have found it very satisfactory to scrape the

The ball is of the standard 3 in. type wound with 25 turns of No. 24 S. S. C. wire B. & S. gauge (No. 22 S. W. G.) on each side of the ball. A new and very satisfactory system of mounting the ball is illustrated in Fig. 3. A threaded bushing with a thin rim is put through a $\frac{3}{16}$ in. hole in the panel. The rim or shoulder prevents the bushing from pulling through. On rear of the panel there is a small piece of L. P. F. also drilled for the bushing and two screws which act as terminals. The bushing is finally clamped in place by a nut bearing on the small L. P. F. piece. A regular $\frac{1}{4}$ in. brass shaft is employed with nuts on the inside and

outside of the rotor to hold it in place. Flexible connections run to the terminals. This type of bearing is far more satisfactory than when holes are drilled in the outer inductance

Drilling the Panels

Fig. 4 gives a scale drawing, one-half size, of the front panel showing the location of the various holes. The L. P. F. panel, measur-

Fig. 4 gives a scale drawing, one-half size, of the front panel showing the location of the various holes. The L. P. F. panel, measur-

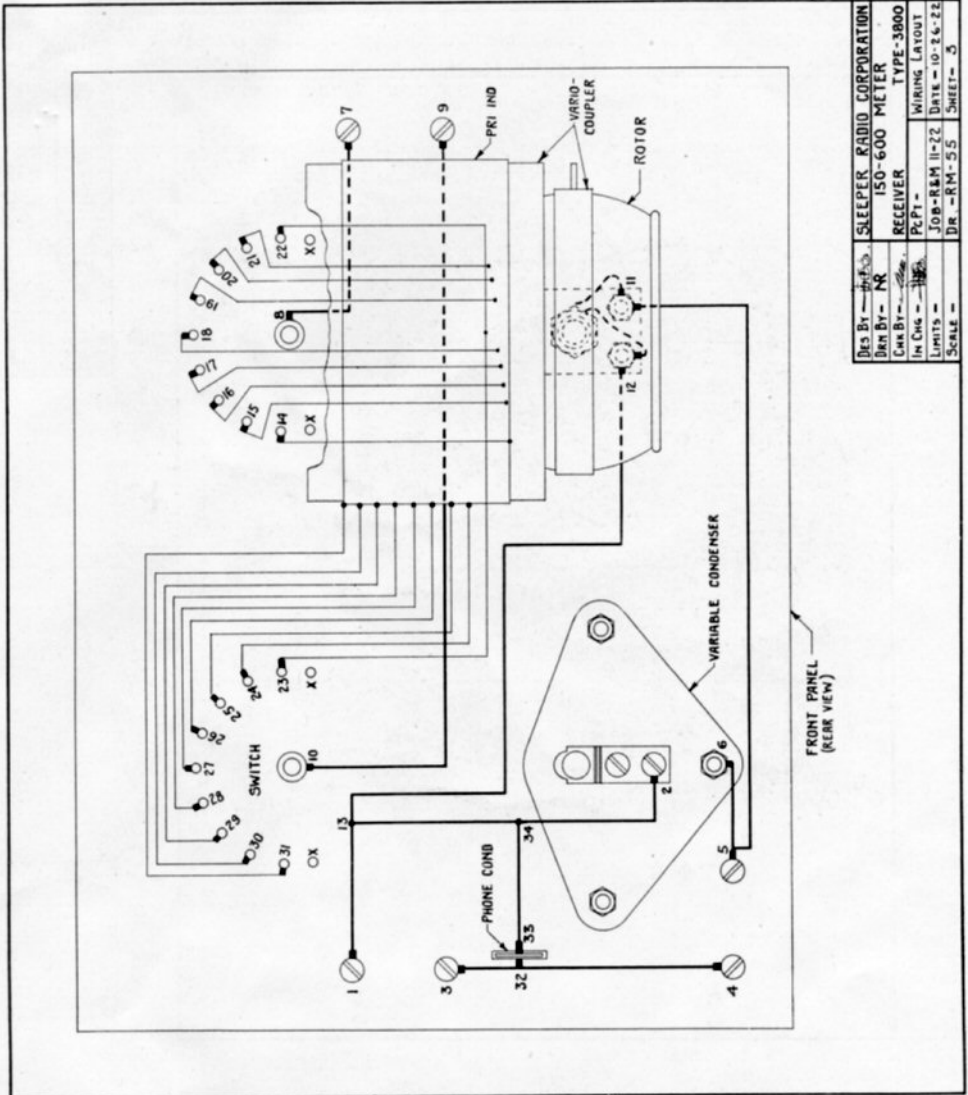

Des By -	W. F. S.	SLEEPER RADIO CORPORATION
Des By -	NR	150-600 METER
Chk By -	W. F. S.	RECEIVER TYPE-3800
In Chg -	W. F. S.	WIRING LAYOUT
Limits -	JOB-B&M II-22	DATE - 10-26-22
Scale -	DR - RM-55	SHEET - 5

Fig. 3. A picture diagram of the wiring at the rear of the panel. By following the numbers you cannot make a mistake in the connections

tube to carry the shaft as the rotor is independent of any irregularity in mounting or drilling the tube.

ing 7½ by 10 ins., ⅜ in. thick, is furnished accurately cut to size so that the holes can be readily located by means of a scribe and com-

bination square. To transfer the dimensions from the drawing to the panel it is only necessary to measure distances between centers on the drawing and multiply them by two. Drill sizes are indicated by number. Two concentric circles indicate that the hole is countersunk for flat head screws.

graving to order so that it should not be difficult to have this work done on a regular engraving machine. The white filling may be a combination of wax and zinc oxide, white lead, or a regular whiting pencil can be used such as is sold by the Dixon Graphite Company.

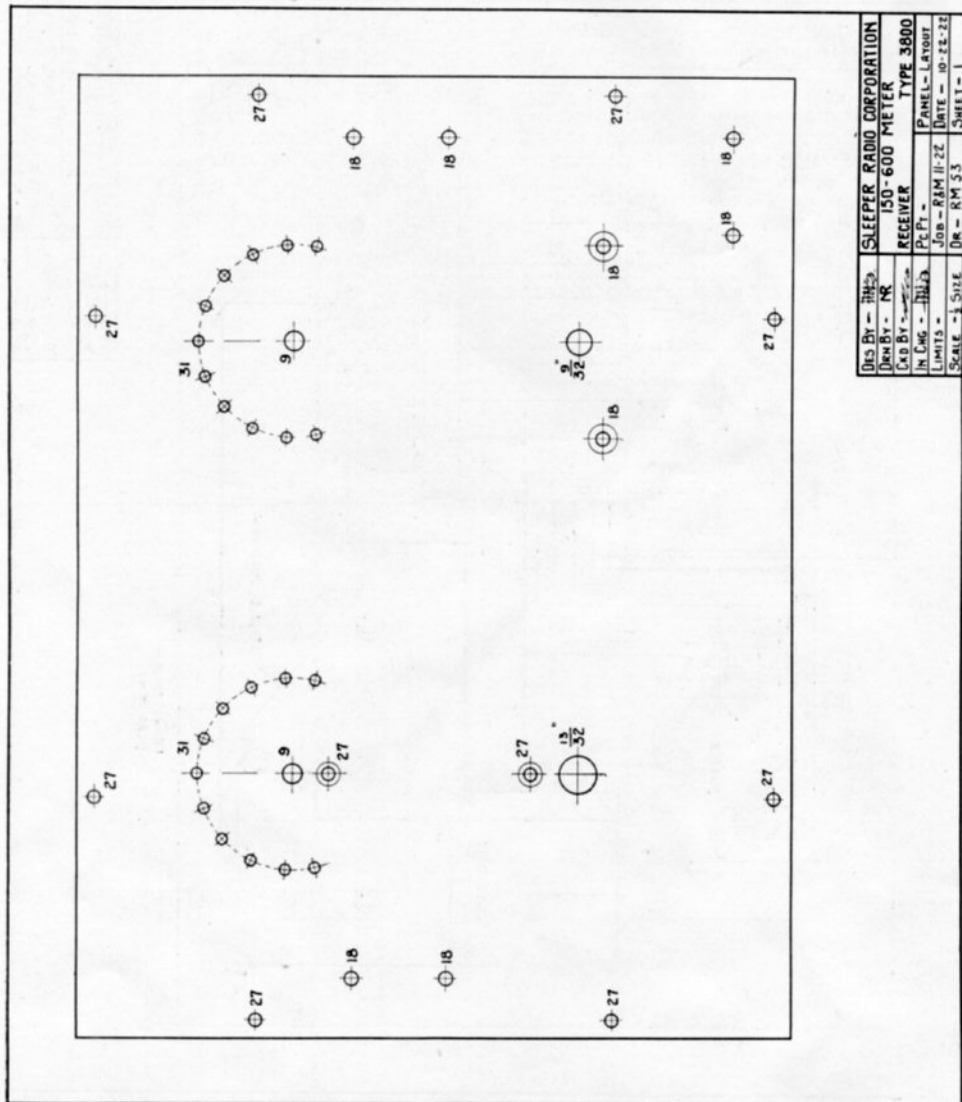

Fig. 4. One-half scale drawing of the front panel. To get true dimensions double each distance measured on the drawing

In the illustrations the panels are shown already engraved. If an experimenter is careful he can scratch the letters by means of a sharp scribe so that they will look quite well. A number of companies, however, are doing en-

Assembly and Wiring

1. Take the four binding posts apart, slip a soldering lug between each washer and screw-head, and mount them so as to have the posts on the front or engraved side

of the panel. All lugs are indicated by short heavy lines, see Fig. 3, and should point in the directions shown in the layout. See diagram numbers, 1, 3, 4, 5, 7, and 9.

2. In the four end holes of the two groups of holes drilled on a circular form, indicated as X in the diagram, insert the switch stops.

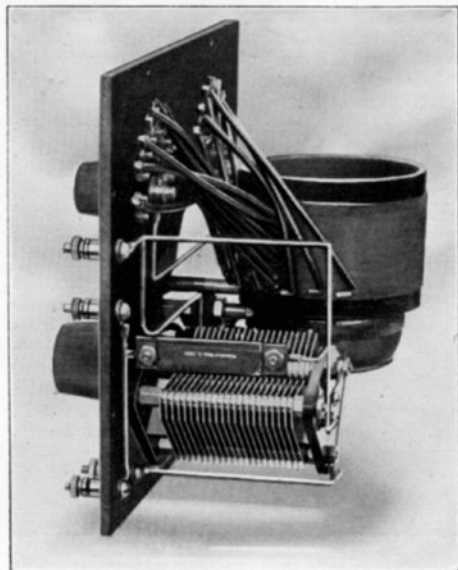

Fig. 5. Here you see the left-hand end of the set. The phone condenser is above the variable one

3. The eighteen contact points are placed in the remaining holes of these groups, with the heads on the front of the panel, and the lugs in the rear, as shown. Tighten the nuts to avoid loose connections.

Note:—Put a little solder on the end of each lug and remove surplus paste with an old tooth brush or cloth.

4. Mount the two switches and tighten rear collars marked 8 and 10, on shaft, making sure that firm pressure is obtained between the switch arm and contact points. The collar marked 8 should be fastened slightly, to permit its removal in a later operation.

5. Next, fasten the variable condenser to the panel with the two 3/8 in. 8/32 F. H. machine screws furnished.

6. Connect 1 to 2, 3 to 4, 5 to 6, 7 to 8, and 9 to 10. To do that, first fit a piece of square tinned wire from 1 to 2, running it as directly as possible with right angle bends, avoiding contact with any intermediate metal or wire. Then solder the terminals neatly. For all other connections, similar fitting and soldering processes are used.

7. The bare wire for taps should be cut into seventeen strips, each about 6 ins. long. Solder one end of these lengths to the copper taps on the primary inductance coil, except on the eighth single turn tap which should have two leads.

8. Take the long coupling ball bushing and slip it thru the 13/32 in. hole drilled for it, with the flange on the front of the panel. After having fastened four lugs to the 1 by 3/8 by 3/16 in. L. P. F. panel, pointing in the directions indicated in the diagram, using two 3/8 in. 6/32 F. H. machine screws and nuts, slip the L. P. F. piece over the bushing. Clamp in place with the hex nut furnished.

9. Connect 5 to 11 and 12 to 13. Also solder the ends of the two flexible leads of the rotor to lugs 11 and 12.

10. Remove the switch shown in the diagram by number 8. Slip the shaft of the rotor ball thru the bushing referred to in paragraph 8. Now, fasten the primary inductance coil to the coil mounting pillars with 3/8 in. 6/32 R. H. screws, and the pillars to the panel with two 3/8 in. 6/32 F. H. machine screws, making sure that the small steps or single-turn taps of the winding are next to the rotor ball, and that the stopping pin on the rotor is not within the tube of the stationary winding.

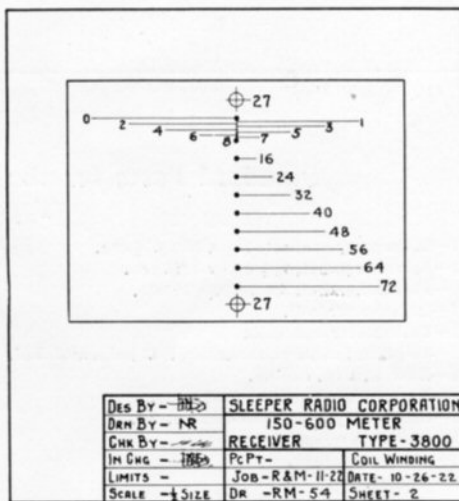

Fig. 6. Location of the taps is shown in this half-scale drawing

11. Remount the switch marked 8. Fasten the 50-degree dial and knob to the rotor shaft of the variocoupler so as to have the O line of the scale and the engraved line on the panel coincide when the winding of the rotor is at right angles to the stationary winding.

12. Take the end of the primary inductance or stationary winding, next to the rotor ball and run it to lug 14. Cut off a piece of spaghetti

long enough to cover this lead from the tube to the lug. Slip it over the wire, and solder it to lug 14. Similarly, connect the next lead from the first turn to lug 15. Continue this process until the eighth turn is connected to lug 22.

13. Take the second lead from the eighth turn, which runs to lug 22, and bring it over to lug 23. Run the next tap above this to lug 24 and continue to 31, which should be the lead from the upper end of the coil winding.

14. To the phone condenser attach a lug at each end, using two $\frac{1}{4}$ in. 6/32 R. H. machine screws. Solder one lug to the connecting wire running from 3 to 4 as shown at 32, setting the condenser at right angles to the panel. Run a wire from the second lug, marked 33, to some suitable point 34, on the connecting wire from lugs 1 to 2.

15. Fasten the 100-degree dial and knob on the condenser shaft, having the 100 line of the scale coincide with the line on the panel when the rotary plates are wholly interleaved with the stationary plates. The set is now ready for external connections and use as soon as the panel is mounted on the cabinet.

Operating and Testing

With the tuner described, only a single wire antenna 100 ft. long and 20 or 30 ft. high is needed in addition to the water

pipe ground, telephones and crystal detector. The detector is not mounted on the panel of this set because experimenters usually have ideas of their own as to the particular type they want to use and it is easier to adjust a detector standing on the table than mounted on a vertical panel. A buzzer test is also necessary to indicate that the detector is on a sensitive spot. The buzzer test consists merely of a small buzzer and dry cell with a wire run from one buzzer terminal to the ground connection. When the detector is properly adjusted the test will produce an audible signal in the telephones.

This outfit is so simple that the possibilities for errors are reduced to loose connections, poorly soldered joints, a short circuit in the telephone condenser or in the variable condenser. These defects can be readily located by means of a buzzer and battery connected across the various terminals.

The range of this set with a good crystal is 25 to 30 miles. If amplification is desired, the type 3100 two-step amplifier should be connected at the input side to the telephone binding posts and the usual connections made to the amplifier. The detector is then adjusted in the usual manner. A very considerable increase in receiving range and signal strength can be accomplished in this manner.

Standard Parts for the 150-2600 Meter Receiver Type 3600

- 1—Mahogany cabinet, $7\frac{1}{2}$ x 15 x $6\frac{1}{2}$ ins.
- 1—Formica panel, $7\frac{1}{2}$ x 15 x $3/16$ ins.
- 1—Formica panel, 5 x $2\frac{1}{2}$ x $3/16$ ins.
- 1—Inductance coil.
- 1—Variometer and dial.
- 1—43-plate variable condenser, .001 mfd. and dial.
- 1—Switch, 1 in. radius.
- 9—Switch points with small nuts.
- 2—Stopping points with small nuts.
- 1—Phone condenser.
- 1—Grid condenser.
- 1—Socket.

- 1—Rheostat.
- 1—1" x $\frac{3}{8}$ " angle bracket—right hand.
- 1—1" x $\frac{3}{8}$ " angle bracket—left hand.
- 4—Binding posts.
- 1—Pkg. $\frac{3}{8}$ " x 6/32 R. H. screws, nicked.
- 1—Pkg. $\frac{3}{8}$ " x 6/32 F. H. screws, nicked.
- 1—Pkg. $\frac{1}{2}$ " No. 6 R. H. wood screws, nicked.
- 1—Pkg. 6/32 hex nuts.
- 3—doz. small soldering lugs.
- 2—2-ft. lengths of Empire tubing.
- 3—2-ft. lengths of copper bus bar, (square tinned).

Standard Parts for the 150-600 Meter Receiver Type 3800

- 1—Mahogany cabinet, $7\frac{1}{2}$ x 10 x $6\frac{1}{2}$ ins.
- 1—Formica panel, $7\frac{1}{2}$ x 10 x $3/16$ ins.
- 1—Variocoupler and dial.
- 1—43-plate variable condenser, .001 mfd. & dial.
- 2—Switches, 1 in. radius.
- 18—Switch points, with small nuts.
- 4—Stopping points, with small nuts.
- 1—Phone condenser.

- 6—Binding posts.
- 1—Pkg. $\frac{3}{8}$ " x 6/32 R. H. screws, nicked.
- 1—Pkg. $\frac{1}{2}$ " No. 6 R. H. wood screws, nicked.
- 1—Pkg. 6-32 Hex nuts.
- 3—doz. small soldering lugs.
- 3—2-ft. lengths of Empire tubing.
- 2—2-ft. lengths of copper bus bar (square tinned).

101 Receiving Circuits

Ninth Installment

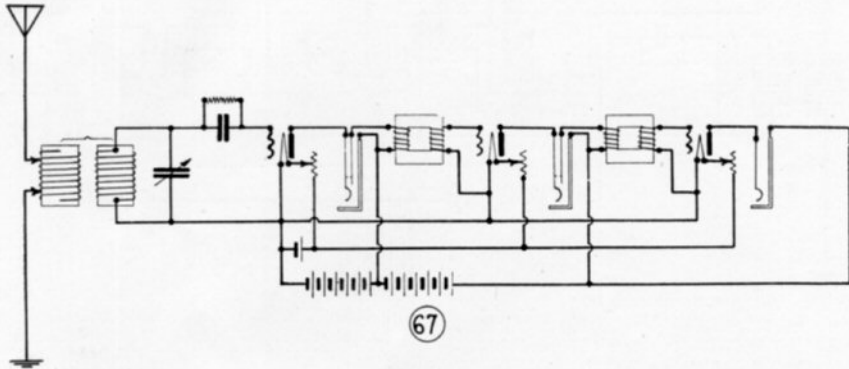

67. Of the several methods for using jacks to which the phones can be plugged in at the detector or successive stages of amplification the method shown here is the most simple. Close circuit jacks are used in the plate circuits of the detector and first amplifier with an open

circuit jack in the last step. Connections are made in such a way that, when the plug is inserted at the detector or first amplifier jack the succeeding transformer is taken out of the circuit. This offers some advantage since it cuts out the impedance of the transformer primary.

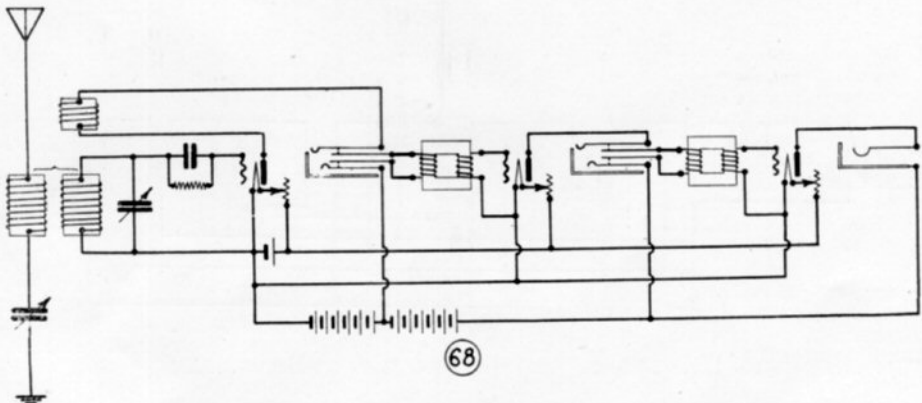

68. Double circuit jacks can be applied to any type of set altho the one shown here is of the tickler coil regenerative type. When the plug is inserted in the plate circuit of the detector or first amplifier both sides of the succeed-

ing transformer are taken out of the circuit. It should be noted that no connection is made to the frame of the double circuit jacks as the long and short arms are in contact with both sides of the plug when it is inserted.

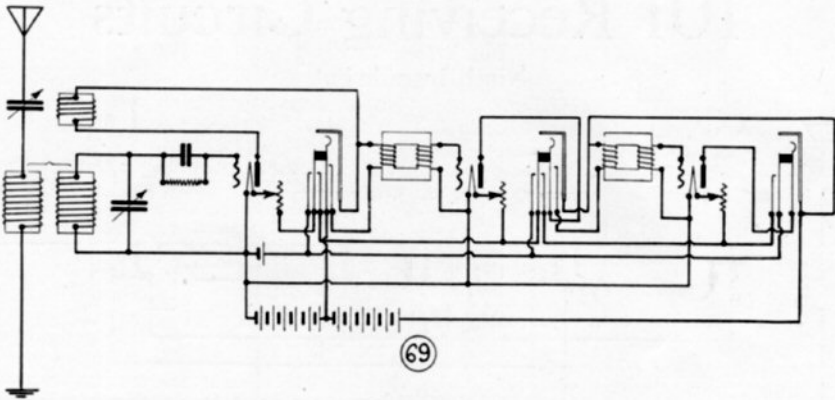

69. Still more wiring is required for the filament control jacks. The type shown in No. 69 opens the filament circuits of the succeeding tubes and cuts out one side of the succeeding transformers. That is, when the plug is inserted in the detector jack the first amplifying transformer is opened at one side and only the detector filament circuit is closed. At the first stage amplifier the detector and first tube

filament are lighted and the second amplifying transformer opened. In the last jack all three tubes are lighted and the phones are inserted in the plate of the last tube. When the plugs are not in any jack all filament circuits are opened. A particular advantage of this method of connection is the fact that both tubes and storage battery are relieved from operation when they are not in use.

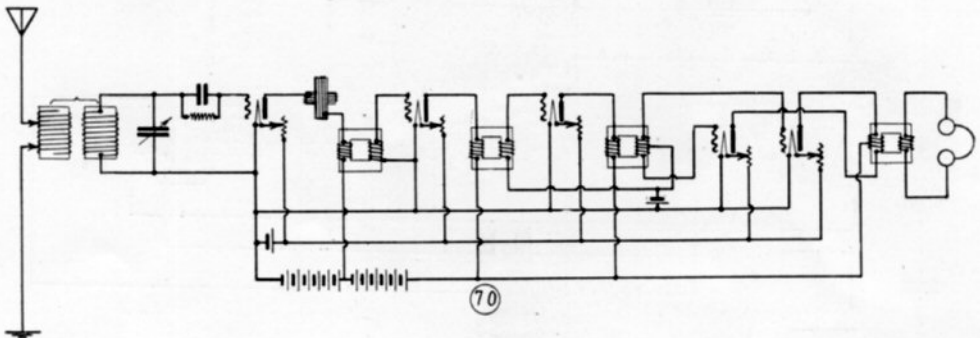

70. In this regenerative circuit two steps of amplification, connected in the ordinary way, are employed with a special power amplifier having a double secondary winding, each half of which is connected to a power tube. The plate circuits of the tubes are joined to an out-

put transformer with a double primary winding.

Having the power tubes connected in this way is of considerable advantage over the ordinary cascade circuit. Note the biasing battery connected to the grid of the second amplifier tube.

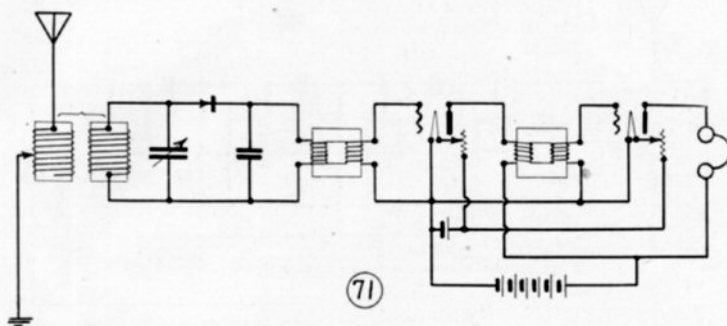

71. Some experimenters prefer to use a crystal detector in place of an audion detector. Aside from the disadvantage experienced with the adjustment of a crystal this is good practice for no distortion is experienced in receiving telephone transmission. The crystal detector is adjusted in the ordinary manner and the one

or two-step amplifier operated just as if it were being used with an audion detector. No special type of transformer is required as the regular types give quite satisfactory results. A disadvantage, however, is that regenerative action cannot be employed.

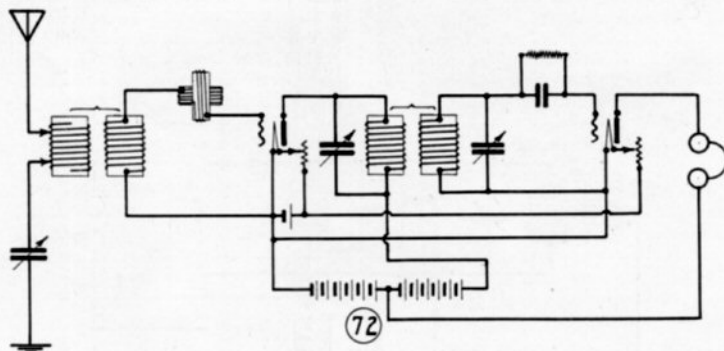

72. This regenerative receiving set employs a variocoupler and variometer in the grid with a tuned plate circuit coupled to a second tuned circuit which is connected to the detector tube. The first tube acts as a radio frequency amplifier. In designing the inductances for the amplifier, plate and detector grid circuits it must be borne in mind that they are tuned to the incoming radio frequency. If a long wave loose coupler is employed and a variable condenser across the secondary all wavelengths can be covered providing that proper adjustments

are arranged for in the two auxiliary tuned circuits.

Tuning is extremely sharp when this system is employed, making it necessary for the operator to learn the approximate position of the various controls at the different wavelength settings. Note that 45 volts is applied to the plate of the radio frequency amplifier tube and $22\frac{1}{2}$ volts to the detector tube. An audio frequency amplifier can be added by inserting the primary of the first amplifying transformer in place of the telephones as shown in the diagram.

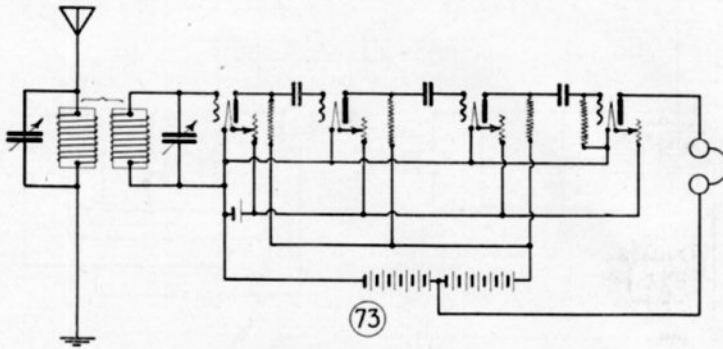

73. Here we have a non-regenerative receiver using resistance coupled radio frequency amplification. The first three tubes are radio frequency amplifiers and the fourth the detector. Audio frequency amplification can be added in the usual manner. Resistances of approximately 24,000 ohms are required in the amplifier plate circuits. As in the preceding

diagram 45 volts is applied to the plates of the radio frequency amplifier tubes and $22\frac{1}{2}$ volts to the detector. The 1 megohm gridleak resistance is shown connected between the detector and filament of the detector. If it were wired in the ordinary manner the 45-volt B battery would be applied to the grid of the detector rendering it inoperative.

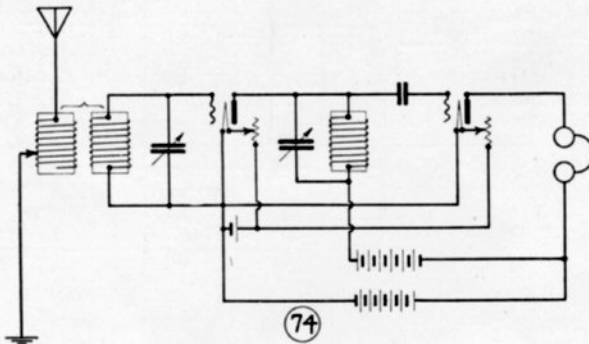

74. One method of obtaining radio frequency amplification is to connect a tuned circuit in the plate of the first tube. This must be of such constants as to tune to the radio frequency of the incoming signals. For a receiving set of 150 to 600 meters no adjustment of the plate inductance is necessary as the range can be covered by the variable condenser. Honeycomb coils are well adapted for use in

this set where a longer wavelength range is to be covered. No gridleak is shown in the circuit altho it might offer some advantage when put across the grid and filament. It is necessary, of course, to keep the plate voltage of the radio frequency amplifier tube from the grid of the detector. Audio frequency amplification can be added by substituting the primary of the first amplifying transformer for the telephones.

RADIO AND MODEL ENGINEERING

A monthly magazine published at
88 Park Place, New York City.

Editor

M. B. SLEEPER

Associate Editor

N. H. RICHFIELD

Circulation Director

F. A. SKELTON

Subscription Rates

Ten cents per copy in the United States and Canada; in foreign countries fifteen cents.

One dollar per year, twelve numbers, in the United States and Canada; one dollar twenty-five cents in foreign countries.

Radio and Model Engineering is mailed to subscribers on the tenth of the month, and appears in the radio stores on that date.

Copyright 1922, by M. B. Sleeper.

EDITORIAL

THAT this is a radio Christmas is evidenced by increased impetus in the purchase of radio equipment. A radio set for a Christmas gift embodies a new idea of unselfishness. It means pleasure for the whole family as well as for the individual. Are you doing your part? Don't be selfish with your set but let everyone hear what you are getting. It is a simple matter to hook up a loud speaker, or if your set is not powerful enough, put on some extra telephones.

A feature of interest to you is the definite and concentrated efforts of radio manufacturers in the selection of new and superior parts for equipment. We cannot assume that today we have reached the limit of possibilities, but are all striving unceasingly in our laboratory research work to develop additional data and working ideas for you. Many experimenters have written in for further information on transmitters. The article which appeared in November is one of a series on this subject, and will be followed by subsequent information of particular interest to you.

What do you know about side-band transmission? There are hints, occasionally, of the system, but very little positive data about this new and very promising method is available. A brief review of the theory sounds like dropping eighty percent of a chemical formula yet getting the same results.

The radio situation in England recalls the stage magician who, after drawing from the hat

handful after handful of tape, suddenly produces a rabbit. After tying up broadcasting and licenses in what appeared to be a hopeless tangle, the essentials of a smooth-running method have suddenly emerged.

Altho the solution of the problems is somewhat different than ours, if we can really say we have one, it would not be right to criticize merely because their angle of approach is quite different. The first aim of the Post Office seems to be that of insuring to the public the very best of broadcasted entertainment, and the opportunity to enjoy it without interference. To centralize the control of programs and finance the stations and their operation a Broadcasting Company has been formed. The capital has been guaranteed by five of the large manufacturers. Other companies, however, can take part by buying one share in the broadcasting corporation. A part of the financing is provided by the Government, which has agreed to turn over one-half of the receiving station license fees. In addition, the manufacturers have agreed to pay heavy royalties on equipment they make.

Attention!

With this issue 3000 subscriptions expire. If yours is among that number, I want to thank you, as one of the first subscribers to R and M, for this confidence expressed in what was really an experiment of mine. I believe you will agree that R and M has developed for itself a position unique among radio magazines.

Its success has not been due to spectacular appeals to the imagination. It has been built upon a foundation of truth and accuracy in the form of helpful ideas for the experimenter who builds his own equipment.

R and M is three times bigger than it was when you first subscribed. If you will do your part, by renewing your subscription immediately, you will meet me half-way in my plans to further improve the articles and their presentation and, moreover, to again treble the number of pages.

If a subscription blank is enclosed with your magazine, rush it back with your dollar bill or check as before.—Are you with me?

M. B. SLEEPER,
Editor.

High Efficiency Variocoupler

A new method for constructing a variocoupler
for short wave work.

IN DESIGNING the variocoupler described below, efficiency, simplicity, practicality, and the elimination of a sliding contact were the prime factors.

The variocoupler is illustrated in Figs. 1 and 2, mounted on a small panel.

Fig. 3 shows the construction and over all dimensions.

from 0 to 72 may be had by simply slipping the switch arms as desired.

The method of tapping the winding is also of interest. Instead of having an extra length of wire brought out by some means or other, which is liable to break when twisted or bent, a small strip of copper is soldered to the winding at the proper turn. This enables one to

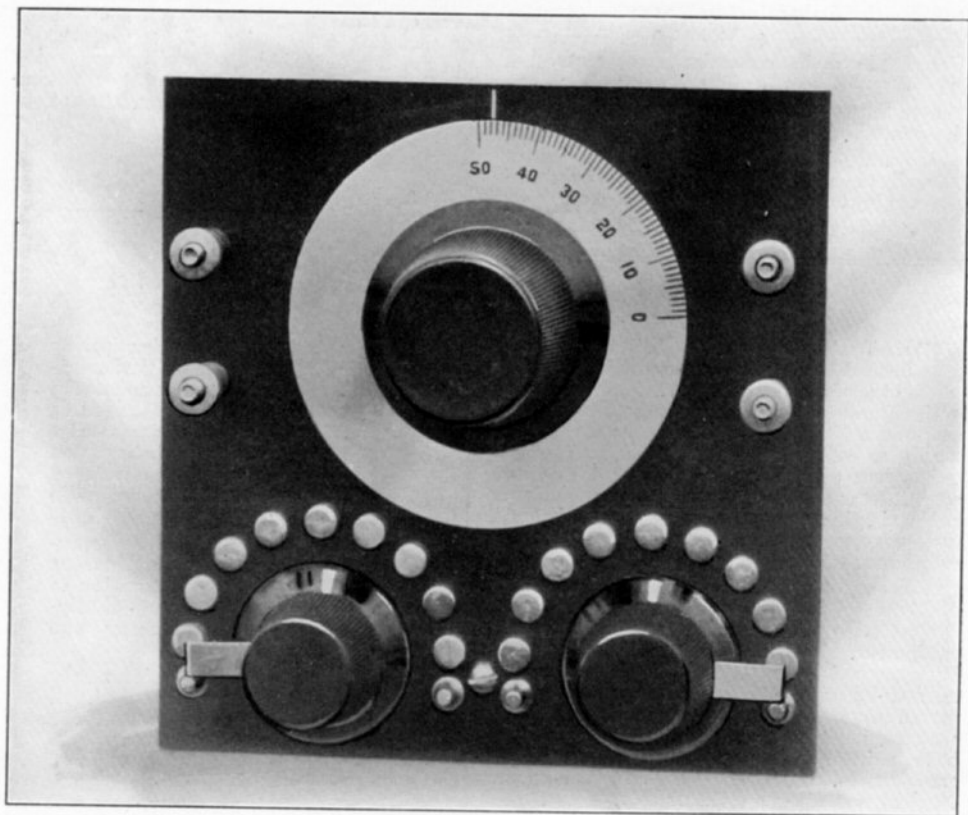

Fig. 1. The variocoupler mounted on a panel measuring 5 x 5 ins. A special feature of this design is that the ball is mounted independently of the coil

The primary or fixed inductance is No. 24 S. S. C. wire wound on a Formica tube $3\frac{1}{2}$ ins. in diameter and $2\frac{1}{2}$ ins. long. This winding has eight single turn taps leading to one set of contact points, and eight taps with eight turns per step to a second group of contact points. With this arrangement, any number of turns

bring proper leads from the taps to the switch points, without fear of the wire breaking and the coil unwinding.

The primary is mounted very simply on the panel with only two $\frac{3}{8}$ in. 6/32 F. H. machine screws.

The rotor ball is turned from well seasoned

mahogany to insure against warping and shrinking, as much of the wood as possible being removed from the inside without sacrificing strength. This, too, is wound with No. 24 S. S. C. wire, 25 turns on each side. Two

coupler is used in circuits utilizing the rotor winding as a tickler coil.

The $\frac{1}{4}$ in. shaft is fastened to the rotor by means of two hex nuts, one outside and the second clamping it from the inside.

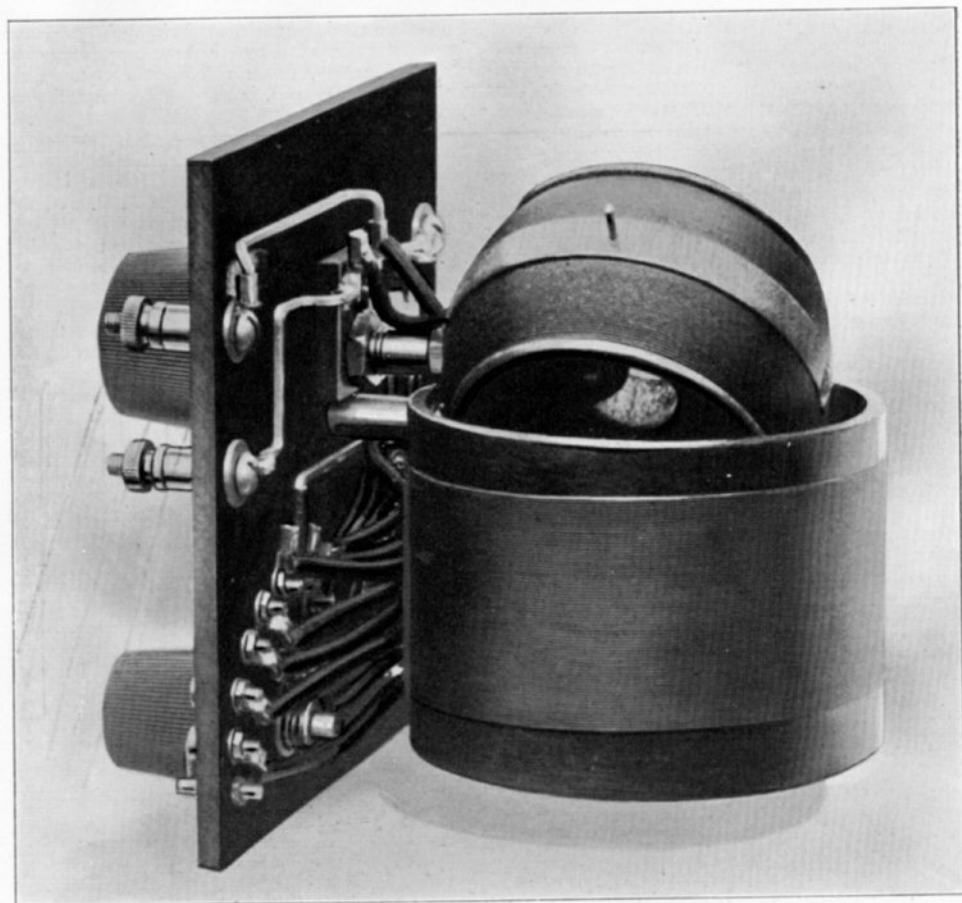

Fig. 2. In this rear view the mounting of the ball is shown

well insulated and very flexible braided leads are brought out through a hole in the rotor. These leads are rigidly fastened to the inside. The ends of the rotor winding are soldered to the leads, which in turn are soldered to lugs on a small Formica block. A pin in the periphery of the rotor prevents it from being revolved completely around and tearing the flexible leads. From this description it will be seen that the general practice of sliding contact for the leads of the rotor winding has been eliminated and that a perfect connection is obtained between the rotor winding and its circuits. This is of particular value when the vario-

A turned bushing provides true and smooth operation of the rotor. The hex nut which holds the bushing in place, also clamps the small block, which carries the rotor winding terminals.

Using the variocoupler in the standard circuits in conjunction with the suitable equipment, accurate and close tuning will be obtained thru a range of about 150 to 600 meters. The range specified may be increased by inserting loading coils in the primary and secondary circuits.

(Concluded on page 181)

150 to 2600 Meter Receiving Set

An unusually substantial and efficient design for those who want to hear both long and short wave stations.

Purpose of the Set

SO GREAT has been the demand for single circuit receiving sets combining in the tuning arrangements an antenna inductance and plate variometer that this set has been worked out to cover the requirements of experimenters who wish to hear not only the short wave transmitting stations but others operating on greater wavelengths such as the station at Arlington, Va. In this outfit one of the new variometers, a type designed to give the very highest efficiency, is used with a winding of four banks. In addition there is a variable condenser in the ground lead, for fine tuning, and a detector with the usual accessories.

The inductance is something of a departure from standard practice in that it is wound with four banks of No. 24 S. S. C. wire, B. & S. gauge, (No. 22 S. W. G.) There seems to be a general impression among experimenters that it is not practical to make windings with small solid wire of more than three banks. In practice, however, it will be found that four banks can be wound on as easily and very nearly as quickly as three.

Since the tuning condenser is in series and not in parallel a small difference in antenna capacity will not greatly effect the wavelength. This value of 0.0003 mfd. is the average capacity of a single wire 125 feet long and 30 feet high.

Mounting and Winding the Coil

The antenna tuning inductance, shown at $\frac{1}{4}$ scale in Fig. 5 is wound on an L. P. F. tube $3\frac{1}{2}$ ins. in diameter and $2\frac{1}{2}$ ins. long with a $\frac{1}{8}$ in. wall. The 4-bank winding of No. 24 S. S. C. wire, B. & S. gauge, (No. 22 S. W. G.) is made by the same process that is employed for a 3-bank winding except that, at the start, four turns are to be on, then three, two, and one. Subsequently four turns up are wound instead of three.

The variation in capacity of the antenna tuning condenser is taken as 0.0001 to 0.0006 mfd. Since this allows a generous margin of capacity on a 43-plate condenser no wavelength overlap is indicated in the table of wavelength ranges for the various taps. With the resultant antenna circuit capacity range of 0.0001 to 0.0002 mfd., the following table has been worked out.



Fig. 1. If you want a first class set, both as to efficiency and appearance, for receiving up to 2600 meters, this is the set to build

Because so many experimenters wish to use a 2-step amplifier this outfit has been designed to line up with the type 3100 amplifier already described. The combination is illustrated in Fig. 1. Detailed illustrations of the interior construction are given in Figs. 2, 3, and 4.

The wavelength range, 150 to 2600 meters, is based on the assumption that an antenna of approximately 0.0003 mfd. is to be employed.

Inductance	Max. Wavelength	Min. Wavelength
0.1 mh.	Tap 1.	267
	Tap 2.	377
	Tap 3.	533
	Tap 4.	
0.2 mh.	Tap 1.	267
	Tap 2.	377
	Tap 3.	533
	Tap 4.	
0.4 mh.	Tap 1.	267
	Tap 2.	377
	Tap 3.	533
	Tap 4.	

0.7 mh.	499	705
1.4 mh.	Tap 5. 705	977

2.5 mh.	Tap 6. 942	1333
5.0 mh.	Tap 7. 1333	1885
10.0 mh.	Tap 8. 1885	2665

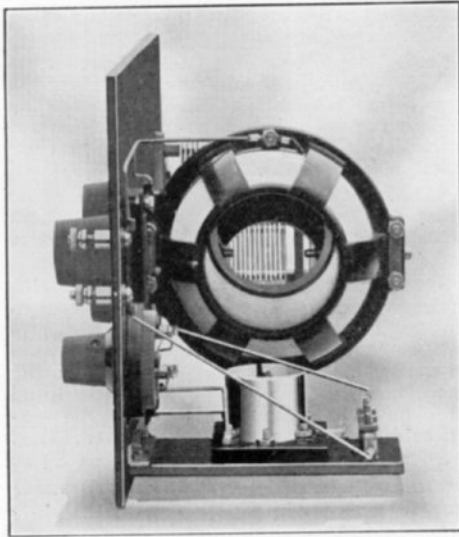

Fig. 2. From the side the variometer and socket mounting can be seen

As shown in the drawing in Fig. 5, the taps should be taken off at the 18, 34, 46, 52, 98, 134, 218, and 324 turns. Nine switch points are used in the set, however, because the start of the winding is brought to the first switch point. This is done to provide a firm anchoring for the lead and not for purposes of tuning. Two No. 27 holes are drilled in the tube to carry $\frac{1}{4}$ in. 6/32 R. H. screws which hold the coil to the supporting brackets. These brackets, also shown in detail at Fig. 6, are formed from brass strip $\frac{3}{8}$ by 1/16 in. The other ends of the brackets are secured to the variometer by removing the screws provided to hold the two halves of the variometer together and putting them through the holes in the brackets. The complete tuning unit is then mounted on the panel by four holes in the base of the variometer. This makes a compact and substantial arrangement. The inductance range of the variometer, 0.07 to 1.14 mh. is sufficient to produce regeneration over the range of the receiving set.

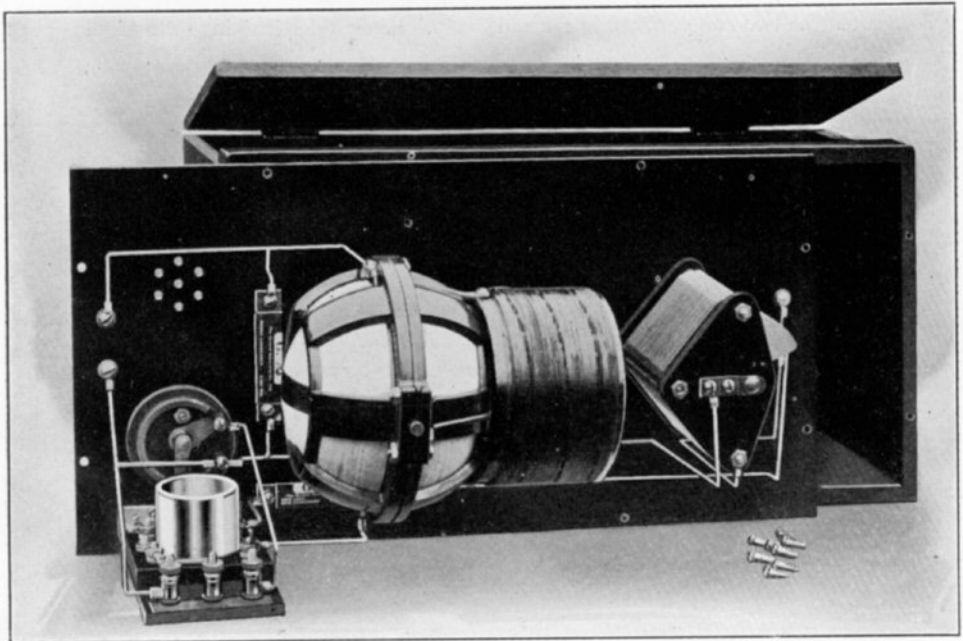

Fig. 3. The rear view shows the simplicity of construction and neatness of arrangement. Binding posts are provided for the addition of the two-step amplifier

Drilling the Panels

An L. P. F. panel $7\frac{1}{2}$ by 15 ins., $\frac{3}{16}$ in. thick carries the instruments. In addition a second panel $2\frac{1}{2}$ by 5 ins., $\frac{3}{16}$ in. thick is used to support the socket and binding posts for A and B batteries. This arrangement makes it possible to bring in the battery leads through small holes in the rear of the cabinet.

Since the drawing in Fig. 5 is exactly one-quarter scale dimensions can be taken directly from the drawing with a pair of dividers. Each dimension should, of course, be multiplied by four. Drill sizes are given by number. Two concentric circles indicate that the hole is to be counter-sunk for a flat head screw.

The holes should be laid out with great care by means of a combination square and slider, each hole being located by a center punch marked to insure accurate drilling. Great care must be taken while the holes are being drilled so that too much pressure will not be exerted at the time when the drill passes through the panel as this will cause the material to chip slightly.

Assembly and Wiring

1. Take the four binding posts with the R. H. screws apart, slipping a soldering lug between each washer and screw-head, and mount them so as to have the posts on the front or engraved side of the panel. All lugs are indicated by the short heavy lines and should point in the directions shown in the layout. See diagram numbers 5, 6, 13 and 32.

2. Fasten the two switch stops, in the end

holes of the primary inductance switch indicated as X in the diagram.

3. In the remaining nine holes under the engraving PRI. IND. insert the contact points, with heads on front of panel, and the lugs in the rear as shown, tightening up the nuts to avoid loose connections.

Note:—Put a little solder on the ends of the lugs before assembling. See suggestions on soldering at end of these instructions. Remove surplus paste on lugs with an old tooth brush or other suitable means.

4. Mount the switch arm, and tighten rear collar on the shaft, making sure that a firm pressure is obtained between the switch arm and contact points.

5. Fasten the rheostat to the panel with the screws furnished, as shown. Shift the rheostat contact arm to the bare portion of the resistance elements as depicted. Slip the knob on the shaft, and tighten the set screw in the knob, when the white lines of the panel and knob coincide. Make sure a firm contact exists between the arm and the rheostat winding.

6. Next mount the variable condenser as shown using two $\frac{3}{8}$ in. 8/32 F. H. machine screws.

7. Take the base panel, and with the screws furnished mount the socket in place. Make sure the slot in the socket is in the same relative position as depicted in the diagram. Failure to observe this precaution, may mean the burning out of the tube.

8. Screw the remaining three binding posts

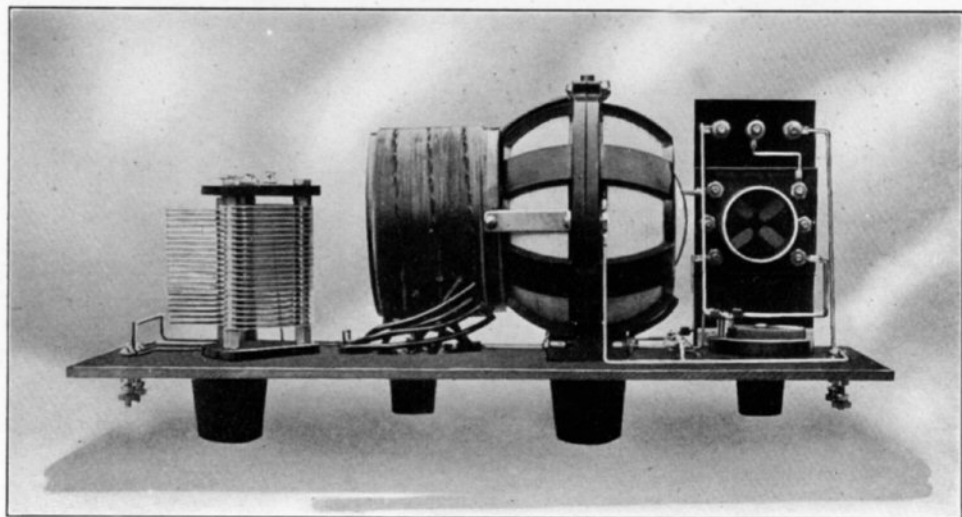

Fig. 4. You can see the method employed for mounting the variometer and antenna inductance from this top view

to the base panel as shown placing the lugs between the post and a washer.

9. Attach the two angle brackets to the base panel with two $\frac{3}{8}$ in. 6/32 F. H. machine screws and nuts.

10. Fasten the base panel to the front panel with two $\frac{3}{8}$ in. 6/32 R. H. machine screws and nuts.

11. We are now ready for the wiring. Connect 1 to 2. To do that fit a piece of square tinned bus wire from 1 to 2 running it as directly as possible with right angle bends, but avoid contact with any intermediate metal or wire. Then solder the wire to the terminal lugs neatly. For all other connections, similar fitting and soldering processes are used.

12. Next connect, in order given, 1 to 3, 4 to 5, 6 to 7, 8 to 9, 10 to 11, 12 to 13, 14 to 15, 16 to 17. This last connection is made by soldering a piece of bus wire about one inch long, one inch from lug No. 1.

13. Solder the wire running from 1 to 2 to the lug marked 18. Connect, 19 to 20.

14. Mount the variometer and primary inductance as depicted. Take the lead from the coil, nearest to the variometer, and run it to lug 20. Cut a piece of spaghetti tubing long enough to cover this lead, and slip it over the wire. Scrape off enough insulation to permit the soldering of the lead to the lug, and solder it. The next tap is brought to lug 21 and the process continued to 28. It will be noted, that

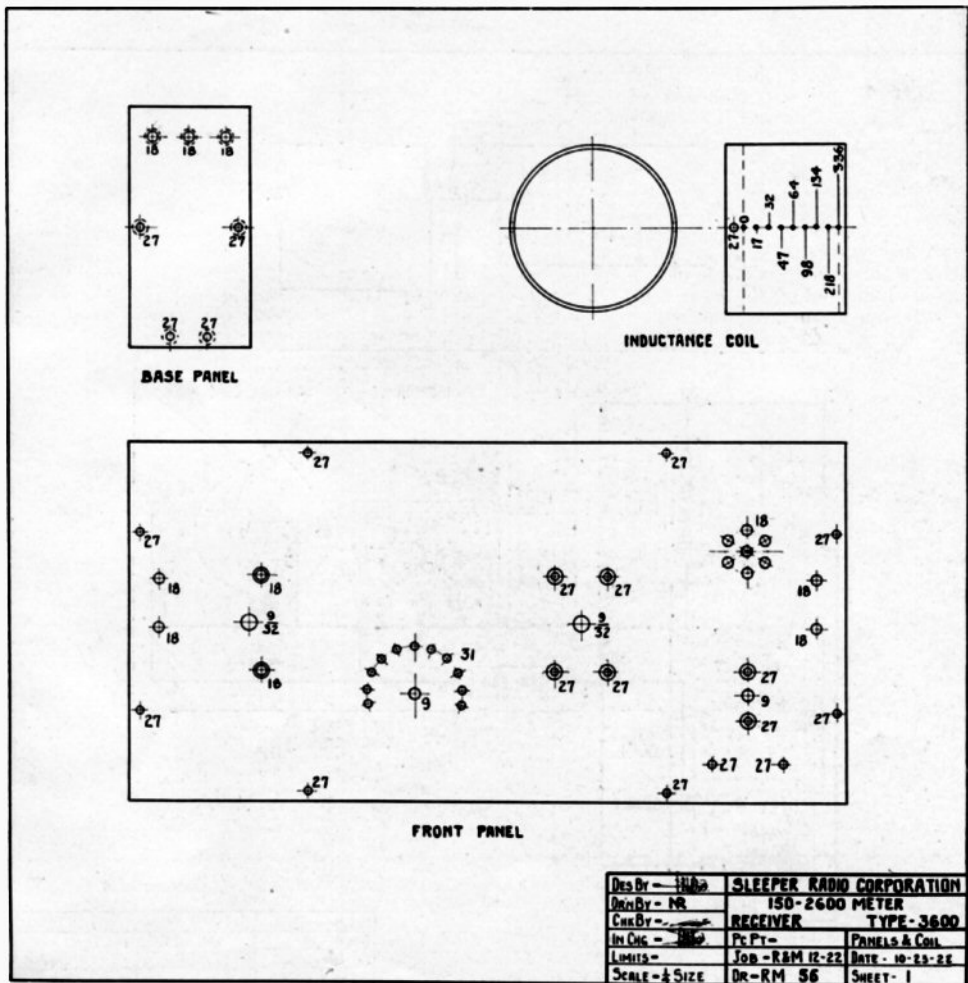

Fig. 5. One-fourth scale drawing of the front panel and tube mounting panel, as well as the coil with the taps numbered as they figure out, while the tap numbers in the text are for top turns

at lug 20 you solder a tap lead as well as the connecting wire 19 to 20 as previously instructed. To facilitate the soldering of leads to lugs, the loosening of the variometer and coil from panel is recommended.

15. Connect 29 to 30, 31 to 32 and 33 to 34.

16. Mount the knob and dial on the variometer, after having it rigidly fixed to the panel, so that the 100 line of dial coincides with the engraved line on the panel when the winding of the rotor and the stationary winding are parallel. Tighten the set screw in the knob.

17. For the variable condenser, have the rotary plates wholly interleaved with the stationary plates, and place the knob and dial on the shaft so that the 100 line of the dial coincides with the line on the panel. Tighten set screw in knob.

Operation and Testing

When the set has been completed each connection should be checked carefully for mistakes or poorly soldered joints. After the antenna and ground connections have been made, the A and B batteries wired to the three terminals inside and the telephones are connected to the output binding posts of the set, the detector should be lighted to full brilliancy and the controls set at approximately the wavelength to be received according to the wavelength table given. As soon as signals are heard and tuned in sharply by further adjustment of the inductance switch and tuning condenser the variometer should be adjusted for regeneration. If the variometer fails to increase the signal strength it should be unfastened from the connecting lugs and induc-

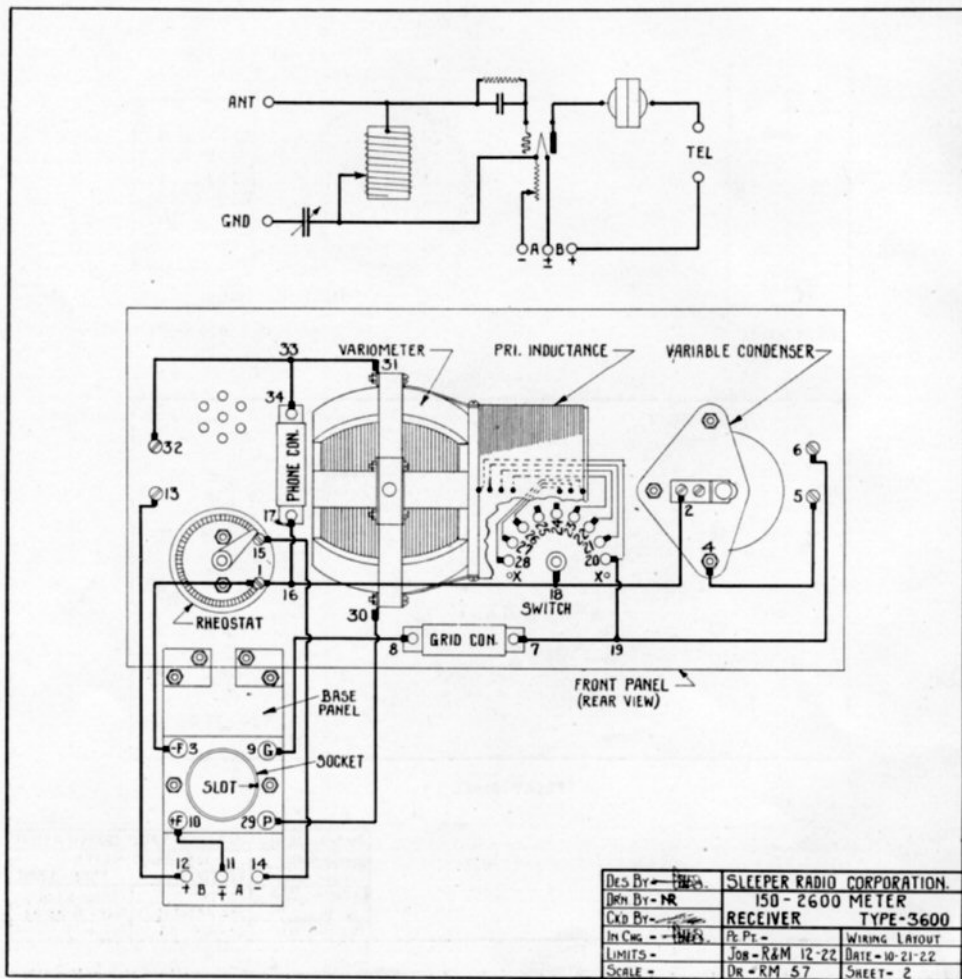

Fig. 6. Schematic and picture diagrams of the receiving set. The latter is drawn from the rear of the outfit

tance coil brackets and turned around 180 degrees. It will then produce the regenerative action desired. To test the set for oscillations wet your finger and touch it to the antenna post. This should produce a clear plucking sound. On some antennas this set may not oscillate at the very low wavelengths. This is due to high resistance in the antenna circuit which absorbs energy from the plate circuit to such an extent that oscillations cannot be set up.

If trouble is encountered test the variable condenser for short circuit and the inductance and variometer for open circuits by means of a buzzer and battery. Sometimes excessive heat in soldering the terminals of the fixed condensers causes them to break down. Occasionally one of the pins of the audion base does not make good contact or the tube itself may be defective. As a last resort take the set to the home of a friend who has a set in operation and substitute his batteries, antenna and ground, and detector tube.

Suggestions on Soldering

Use a small soldering iron. Clean tip well, by filing away scale and old solder. After heating iron, clean tip again and tin it, that is to say, cover tip of iron with soldering paste and a thin smooth coat of solder. Keep iron clean by wiping it frequently with a cloth.

When making a soldered joint have parts cleaned or scraped thoroughly. Apply just enough flux to cover parts. Use only enough solder to make a good joint.

Good soldering requires a little experience on the part of the Experimenter, but there can be no excuse for some of the extremely careless work on many sets which are brought in with the query, "Can you tell me why this set doesn't work"? If you can't make neat joints when you first try, practice on some spare pieces of wire. But don't ruin good parts by gumming them up with lumps of solder.

High Efficiency Variocoupler

Continued from page 175

Experimenters are apt to think of a variocoupler as an instrument to be used only in a variometer type regenerative receiver. This is not true, however, for a variocoupler can be connected as a loose coupler in a crystal or non-regenerative receiver. It is necessary, of course, to shunt the coupling ball, or secondary inductance, by a condenser of 0.001 mfd. to tune over the rated range of 200 to 600 meters. In a small portable set, if maximum efficiency is not required and space is limited the condenser can be omitted.

In addition to the circuits mentioned, a variocoupler can be used in a single circuit regenerative receiver or as coupling between a

radio frequency amplifier and detector. For such a circuit two couplers are required. The first one has the primary connected to the antenna and the secondary, with its shunt condenser, to the grid and filament of the radio frequency amplifying tube. The primary of the second is inserted in the plate circuit of the radio frequency tube and is shunted by an 11-plate variable condenser. Then the secondary, shunted by another 43-plate condenser, is wired to the grid and filament of the detector tube. If regeneration is needed, a variometer can be inserted in the detector plate and the primary of an amplifying transformer, also, when audio frequency amplification is used.

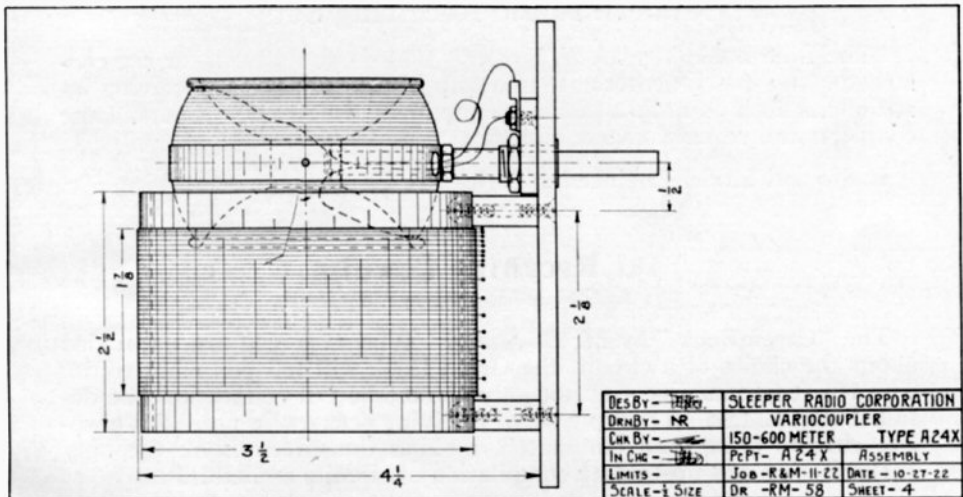

Fig. 3. Half-scale drawing of the variocoupler, showing the over-all dimensions

Your Construction Set Without Cost

HUNDREDS of R & M subscribers are buying their parts with APPARATUS COUPONS—why not you? Sign up with the others and get the parts for your set without cost. A few minutes of your spare time each day will soon net you enough COUPONS to buy you a complete Sleeper Construction Set. One man got his book filled in twenty-four hours, and has nearly filled a second one. The fun in Radio is building your own, so don't wait until tomorrow—write in today to Mr. Skelton, Circulation Director of Radio & Model Engineering, and he will send you a book of ten subscription receipts. For each year's subscription to R & M that you obtain, he will give you an APPARATUS COUPON which is the equivalent of 50c. in cash. When you have sent in 10 subscriptions you are entitled to two extra Coupons. This makes a total of 12 Coupons or six dollars in trade—by obtaining only ten subscriptions. Write NOW and get your receipt book by return mail with ample supplies and complete information on obtaining subscriptions.

This offer applies to Radio Clubs as well—Don't miss this opportunity to help you in the installation of your equipment.

Books for Your Radio Work

Modern Radio Receiving Sets

"The Brown Book," by *M. B. Sleeper*. A strictly constructional book of splendid photos, scale drawings, and clear instructions for building crystal and audion receivers, short and long wave regenerative sets, detectors and amplifiers. The designs are planned so that you can build the sets in your kitchen table workshop.

Radio and Model Engineering Series No. 1. Postage 4c... Price, 50c.

Modern Radio Receiving Sets

"The Blue Book," by *M. B. Sleeper*. This is also a book for the constructor and experimenter. It takes up a wide variety of receiving instruments such as radio and audio amplifiers, variometer tuners, loose couplers, and regenerative equipment.

Radio and Model Engineering Series No. 2. Postage 4c... Price, 50c.

101 Receiving Circuits

Ready for delivery February 1, 1923

The "Green Book," by *M. B. Sleeper*. Whenever you are undecided about the choice of a circuit, the Green Book will tell you what to do. The 101 diagrams give you not only the method of connection but detailed information on every type of receiving set now in use. All obsolete circuits have been eliminated, making the Green Book the only authoritative and up-to-date compilation of circuits available.

Radio and Model Engineering Series No. 3. Postage 4c... Price, 50c.

Sleeper Radio Corporation

88 Park Place, New York, N. Y.

Good dealers throughout the United States carry Sleeper products. Please order from them wherever possible. If there is no dealer in your town, orders may be sent direct to the factory, terms 25% cash with order, balance C. O. D.

SLEEPER RADIO CONSTRUCTION SETS

These are complete sets furnished knocked down for home assembly, requiring no tools except pliers, screw driver and soldering iron. Complete to last detail with fullest instructions.

Cat. No.		Price
3100	Cabinet Type two step power amplifier for use with any of the well known Sleeper Construction Sets described in "Radio & Model Engineering," Brown or Blue Books or with any tube sets. Detector and Amplifier Jacks	\$28.00
A-3100	Same as above, completely assembled, ready for use	35.00
3900	Cabinet Type 150-600 meters. Loosely coupled receiver with detector and two step amplifier with jacks, for long distance reception. Provided with connections for loading up to any wave length	48.00
A-3900	Same as above, completely assembled, ready for use	65.00

Construction sets include every item for assembly including screws, nuts, washers and bus bar for connections. Only auxiliary equipment needed is tubes, batteries, phones and antenna material.

SLEEPER RADIO CONTROL UNITS

Cat. No.	Completely assembled laboratory type open panel units.	Price
2000	Universal tuner 150-750 meters	\$12.00
2800	Audion Detector Unit	5.95
2900	Audio Frequency Amplifier Control Unit	13.95
2200	Detector and two step Amplifier Unit	28.00
2901	Radio Frequency Amplifier Control Unit	12.00

SLEEPER STANDARDIZED CONSTRUCTION PARTS

A-15	Sleeper Variable Condensers, 11 Plate .00025	3.25
A-16	Sleeper Variable Condenser, 23 Plate	3.50
A-17	Sleeper Variable Condensers, 43 Plate	4.30
A-95	Sleeper Patented Vernier Condenser	1.75
A-200	Sleeper Patented 43 Plate Condenser with Vernier, with knobs and 3-in. dial	6.50
A-88	Sleeper Indicating Knob for 3/16" shaft	.35
A-21	Dial and Knob 90° 1/4" shaft	1.00
A-20	Dial and Knob 180° 1/4" shaft	1.00
	(Above numbers furnished for either 3/16" or 1/4" shaft upon special order)	
A-9	Sleeper Switch 1" radius	.60
	(1 1/2" radius furnished on special order)	
A-7	Sleeper Switch Points 1/4" diam., 1/8" high, 1/8" shank	.04
A-35	Sleeper Open Circuit Jacks	.70
A-36	Sleeper Closed Circuit Jacks	.80
A-22-X	Sleeper Rheostat Complete with knob	1.00
A-108	Sleeper Rheostat Complete with vernier attachment	1.50
A-1-X	Sleeper Vacuum Tube Socket	.80
A-14	Sleeper Audio Frequency Transformer	6.00
A-25	Sleeper Radio Frequency Transformer	4.00
A-101	Sleeper Moulded Variometer	7.50
A-24-X	Sleeper Short Wave Variocoupler	5.50
	(150-600 meter)	
47	Sleeper Square Tinned, Copper Bus Bar—Standard 2' lengths, package of 10 lengths	.45
58	Sleeper Soldering Lugs for Bus Bar Wirings, per 25	.20
X-19-33-F	Front Panel—L.P.F.—7 1/2 x 15 x 3/16—drilled and engraved—for 150-600 meter—short wave receiver	5.75
X-19-30-B	Base Panel—L.P.F.—2 1/2 x 5 x 3/16—drilled for 150-600 meter short wave receiver	1.00

WELSH

PEANUT

TUBE

W.T. 501

"The Tube That Cannot Squeal"

Sold for experimental use as a detector only

\$200

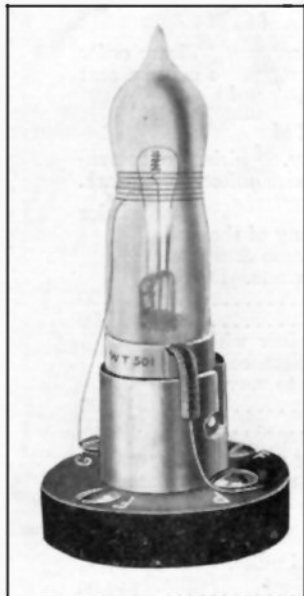

Long Life. Uses only $\frac{1}{2}$ amp. on three dry cells or regular six volt "A" battery. Plate voltage 16-22 $\frac{1}{2}$ v.

Nickel plated socket, moulded base, double spring contacts, 40c. extra.

Adaptors to fit Standard V.T. Sockets, 75c. extra.

Actual size 2 $\frac{1}{4}$ inch. without base.

Wiring diagram packed with each tube showing how to use the W.T. 501 with any crystal set.

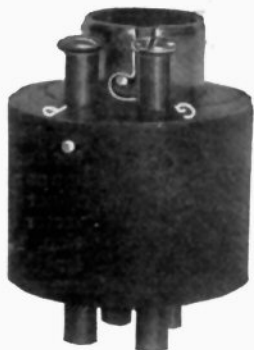

Adaptor

Show this ad to your dealer; if he hasn't got his stock yet, send us his name and we will send direct by mail safely packed post paid \$2.

RADIO TECHNICAL LABORATORIES
MANUFACTURERS

RADIO EXPERIMENTERS' LEAGUE
"RUN BY AMATEURS FOR AMATEURS"



Dec. 2, 1922

Radio Research Guild. re TEST 112922
Newark, New Jersey.

Gentlemen:

The W.T. 501 detector tubes submitted to us for test are being returned to you today with test records.

These records we consider speak favorably of the high quality of your tubes particularly in view of the low current consumption.

The detectors function clearly, with good volume and a minimum of distortion. We have carefully tested each tube individually and over a wide range of conditions. We also note a complete absence of any tendency to howl. Answering your other question specifically: We believe your method of construction renders it practically impossible for it to howl. We believe you are quite justified in advertising your W.T. 501 detector tubes as "The Tubes Which Cannot Squeal".

Respectfully yours

Radio Technical Laboratories.

K. per Chief testing dept.

Hook the W. T. 501 right up with your crystal set. No need to discard any apparatus. (Full directions packed with each tube.) If you own a tube set use the W. T. 501 and the special adaptor to fit V. T. socket.

NEWARK, N. J.

Dec., 9, 1922

Radio Research Guild
9-15 Clinton Street,
Newark, N. J.

Gentlemen:

Thank you for your promptness in shipping us the 100 W.T. 501 detector tubes.

We have tried them out on all sorts of hook-ups and the members are enthusiastic about them.

From now on no one needs to bother with a crystal set as you have placed the price of a tube within the reach of everyone. We are glad to place the W.T. 501 PEANUT tube on our list of approved apparatus and are so notifying our members.

The enclosed order for 300 more tubes is for use here locally and we certainly hope you will rush them to us--our dealers are clamoring for them.

You are to be congratulated on what you have accomplished. The W.T. 501 surely is "The tube without the squeal!"

Sincerely yours

Radio Experimenters' League.

per *[Signature]*
Secretary

WG/56.

RADIO RESEARCH GUILD

9-15 Clinton Street

Newark, N. J.